



**SOMMER**

 SOMIlog2

# Barriers

Access control system for your entrance



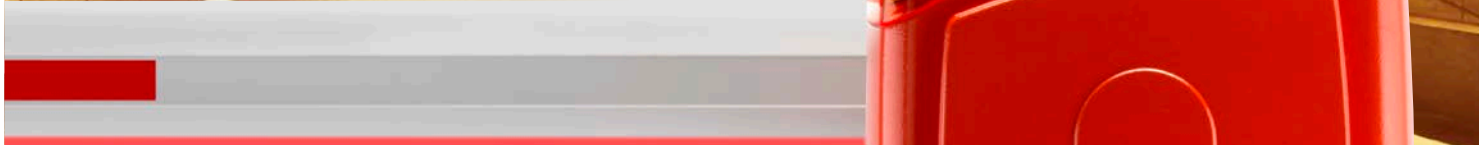
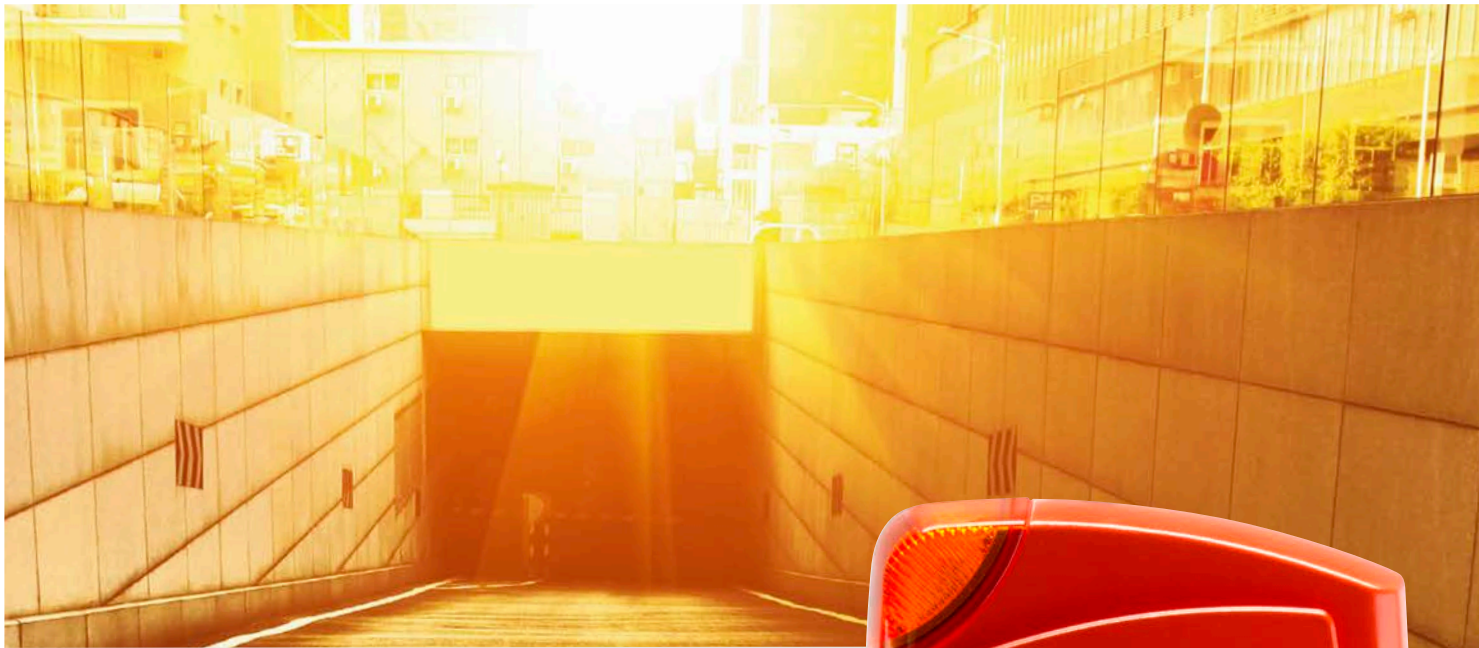

### Explanation of symbols



Bidirectional radio system enables active communication between transmitter and receiver.



Maximum protection against hackers thanks to 128-bit AES encryption with Rollingcode.



Disturbance-resistant radio signal guarantees a large range and reliability.



Durable, energy-saving and efficient lighting thanks to state-of-the-art LED technology.



Connection for battery pack possible. Supplies energy to the operator for up to 12 hours in the event of a power failure.



Energy-efficient consumption on standby.



Operators and radio receivers with this symbol are supported by the SOMlink service interface.



# WE DELIVER THE QUALITY – YOU ENJOY THE CONVENIENCE!

With reliable products from SOMMER, you can be assured of durability for years to come. This is not only because of their high quality and easy operation, but also because they are meticulously

crafted and certified, which allows you to find the perfect barriers for your entrance. The operating forces are certified to EN 12453.



## YOUR SAFETY IS WHAT DRIVES US

Safety and accident prevention are the highest priorities for SOMMER. Our barriers are equipped with dependable technology that complies with applicable standards.

The automatic obstacle detection provides protection by automatically opening when an obstacle is encountered (reversion). The Dynamic Power System automatically reads in the required force and adapts it to changing outside conditions.

The ASB aluminium has a warning light integrated in the aluminium housing. This means you benefit from an attractive design as well as optimum safety.

Set up, plug in, done! Installation couldn't be easier. The boom can be shortened on-site to fit your requirements in just a few work steps. And with SOMMER, you can order exactly what you need: Both left- and right-closing models can be manufactured in our production facilities.

This means no adaptations are necessary during installation.

You also profit from the lightweight aluminium material during installation. Easy handling makes for short assembly times. With maximum stiffness, the ASB aluminium is extremely sturdy and has a very long service life. It can withstand even the toughest weather conditions. The countless connection options will also win you over.



BARRIERS:

WE HAVE THE  
**RIGHT** ACCESS  
CONTROL SYSTEM  
FOR YOUR  
ENTRANCE

4

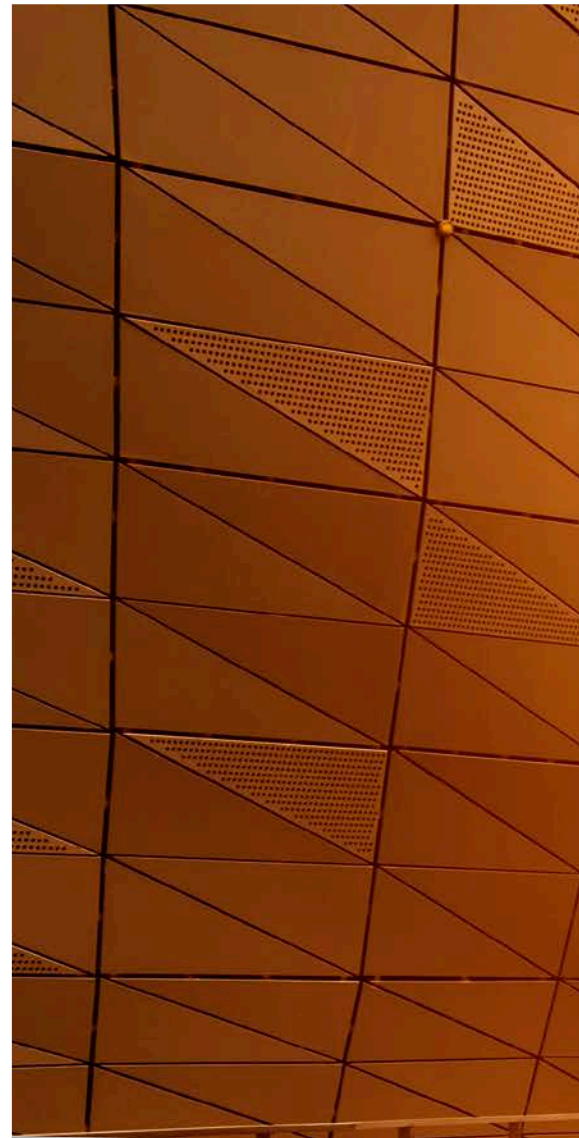

**[ FOR PRIVATE OR COMMERCIAL PREMISES:  
OUR BARRIERS ARE ALWAYS THE RIGHT CHOICE ]**

SOMMER has an attractive complete solution if public parking spaces need to be secured against unauthorised entry: Our barriers are extremely reliable and need very little maintenance.



In the case of the boom LED 500, a traffic-light function can be realised with the additional relay "Relay".

**SOMMER**  
www.sommer.eu



# BARRIERS

## ROBUST AND VERSATILE

### **Economic installation**

Thanks to Plug & Go, installation consists only of set-up and connection.

### **Convenience**

As we can supply both left- and right-closing booms, here, too, no adaptation is necessary during installation.

### **Flexible adjustment**

The boom can be shortened on-site to the exact dimensions. This allows for customised production directly at the construction site.

6

### **Connections for safety accessories**

All connections for safety-relevant accessories are already present.

### **Safety due to obstacle detection**

The operating forces of the booms are certified to EN 12453. The automatic obstacle detection provides additional safety. The boom opens automatically reverses if an obstacle is encountered; this ensures that vehicles will not be trapped.

### **Emergency release in the event of power failure**

In the event of a power failure, the mechanical emergency release can be activated to open or close the barrier. Alternatively, emergency operation via a battery pack is possible.



**SOMMER**  
[www.sommer.eu](http://www.sommer.eu)

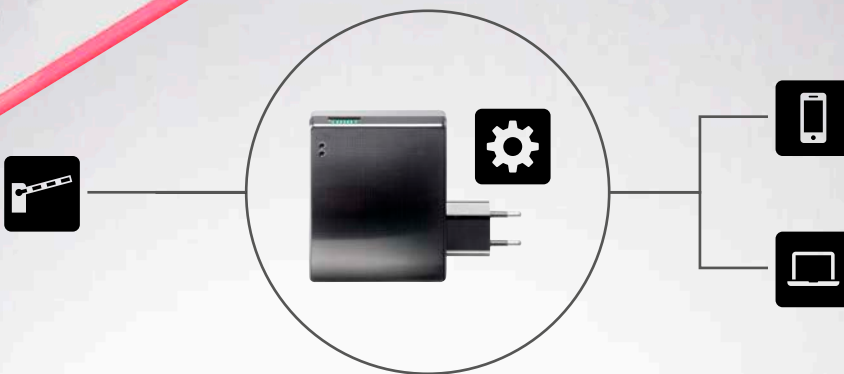

### SOMlink app for Android

This app facilitates  
connection set-up.



## SOMlink

With this intelligent control technology for specialist retailers, there are additional options for easily adjusting features and parameters using your smartphone, tablet PC or laptop.

### Compatibility

Service interface for operators and radio receivers with SOMloq2 radio system.

### Technology

- Integrated WiFi module
- Integrated web server
- Universal for smartphones, tablets or laptops
- Interface between WiFi and SOMloq2 radio system
- No saving of data on external servers
- No on-site Internet connection required! A direct WiFi connection is established between smartphone, tablet PC or laptop and the SOMlink.

### Diagnosis and service

- Help with commissioning: Deleting transmitters, programming force values and much more
- Changing operator settings: Configuring lighting duration, speeds, pre-warning times, safety devices and much more
- Calibrating force values
- Reading out, saving and loading system data
- Reading out diagnostic information: Cycle counter, event history, visualisation of the force curves and much more



# ONE CONTROL UNIT, A WIDE RANGE OF CONNECTION OPTIONS

The range of functions of the barriers can be expanded as required with a wide range of connection options and accessories.

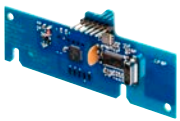

**1 HomeLink radio receiver module**  
With the integrated HomeLink radio receiver, the barrier can be upgraded to the HomeLink radio control system. The barrier can then be controlled with a HomeLink transmitter integrated in the vehicle.



**4 Memo**  
Expands the memory of the handheld transmitter to 450 handheld transmitter commands. Allows the use of transmitter management Codemaster<sup>+</sup>.



**Lumi Strips**  
With the additional equipment "Relay", the Lumi Strips can also be installed in the side of the housing, adding a further attractive visual element.

**Lumi Strip traffic light** to display blocked or enabled drive-through in red and green.

**Lumi Strip lighting/warning light** warning of a movement of the boom or as additional lighting in white and yellow.

8



**2 Battery pack**  
In the event of a power failure, the battery pack supplies energy to the barrier for up to 12 hours with a maximum of 10 cycles.



**5 Output OC**  
Open collector output for transmission of a static signal for display of the opening status to Smart Home systems or for activation of additional lighting with 24 V.



**3 Buzzer**  
Warning buzzer that outputs an acoustic signal during the closing process.

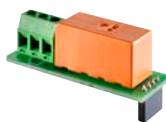

**6 Relay**  
Relay with potential-free changeover contact for activating external lighting or querying the opening status.



Barrier with additional equipment  
Lumi Strip traffic light in housing.



## Further connection options

- 7** Connection option for voltage supply, 12 V and 24 V, for external devices
- 8** Connection option for 3-way button for defined activation of OPEN, STOP and CLOSE
- 9** Optional connection of two induction loops (potential-free contact of a separate evaluation unit)
- 10** Connection option for a timer contact
- 11** Connection option for the potential-free normally closed contact of a fire alarm system
- 12** Connection option for a 2-wire or 4-wire photocell
- 13** Connection option for a 24 V / 3 W warning light



The integrated shaft for a battery pack allows quick and easy installation.

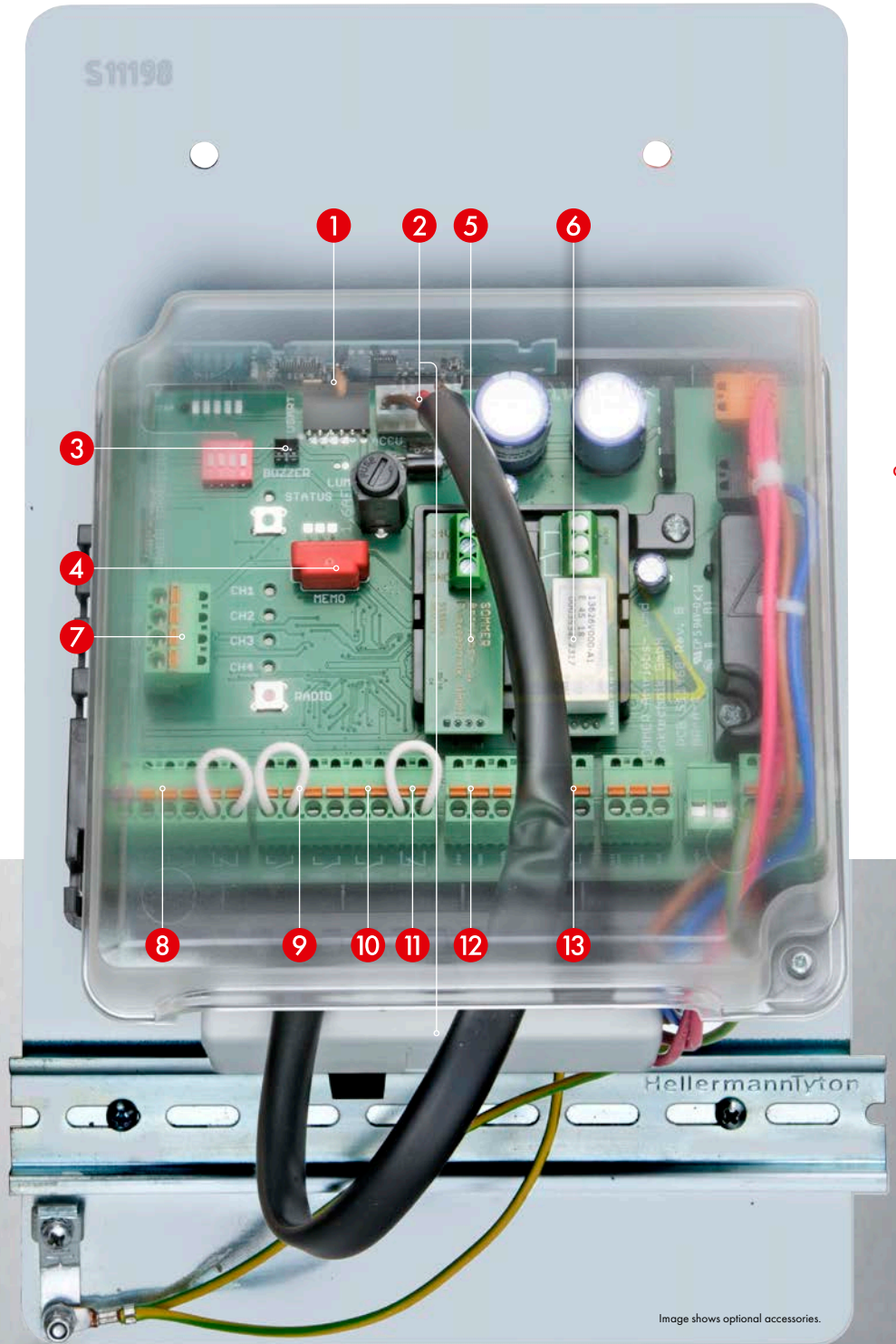

Image shows optional accessories.



# MODERN, BIDIRECTIONAL RADIO SYSTEM

For maximum convenience, we offer the corresponding radio products for all modules. With the data- and transmission-secure radio system, you no longer have to get out of the car when it's raining, snowing or dark outside.

The bidirectional radio control system offers numerous additional functions which make everyday life easier – from feedback on whether the radio signal is being received to status queries of the door to auto repeat and hop functions.

Control your systems conveniently with a handheld radio transmitter and benefit from our SOMloq2 radio control system when opening the barrier.

## 10 Your key benefits with the SOMloq2

### Secure encryption

The future-proof SOMloq2 radio control system offers maximum data protection against hackers thanks to 128-bit AES encryption with rolling code.

### Repeating radio signal

The auto-repeat function ensures convenient opening while approaching the building. The output radio signal repeats in a certain cycle to permit optimal availability.

### High radio range

An innovative hop function extends the range, as radio signals are forwarded from SOMloq2 receivers.

### Also for existing SOMMER operators

Transmitters with the SOMloq2 radio control system are backward compatible with the Somloq Rollingcode radio system, making it possible to control existing operators and radio receivers.

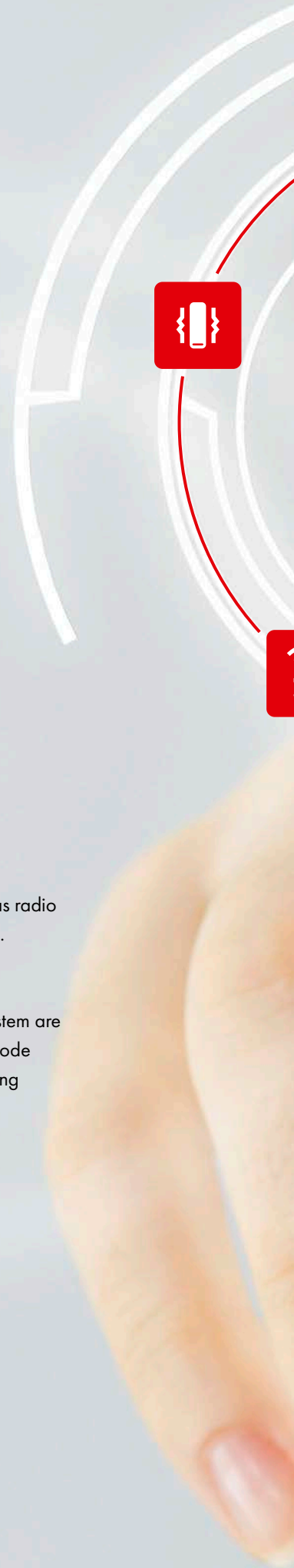





# THE CHOICE IS YOURS

SELECT A BARRIER BODY AND BOOM AND CONFIGURE YOUR OWN BARRIER



ACCU READY



≤1,3 W STANDBY



## ASB aluminium

- Barrier made of lightweight aluminium and therefore easy to transport and install
- Integrated warning light and status display with clearly visible signalling effect
- Can be supplied as both left- and right-closing models. No adaptations are necessary during installation.
- Convenient operation via radio thanks to the integrated radio receiver with bidirectional SOMloq2 (FM 868.95 MHz) radio control system
- Automatic obstacle detection ensures that the barrier opens automatically when it encounters an obstacle so that no vehicle gets wedged in
- The barrier can be manually locked and unlocked in any position (e.g. in the event of a power failure)
- Wide range of connection options for accessories
- Rugged, high-quality components guarantee a long service life
- Pre-programmed Pearl Vibe 4-command handheld transmitter with noticeable feedback of radio commands via vibration

12



Right-closing



Left-closing



TECHNICAL DATA	ASB ALUMINIUM	ASB STEEL
Weight	50 kg	60 kg
Temperature range	-25 °C ... +65 °C	-25 °C ... +65 °C
Max. opening width	5.5 m	5.5 m
Rated voltage	AC 220-240 V	AC 220-240 V
Rated frequency	50/60 Hz	50/60 Hz
Motor output	60 W, DC 24 V	60 W, DC 24 V
Max. cycles per day	350	350
IP code	IP44	IP44



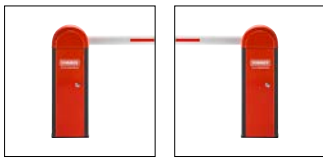

Right-closing

Left-closing

## ASB steel

- Can be supplied as both left- and right-closing models. No adaptations are necessary during installation.
- Convenient operation via radio thanks to the integrated radio receiver with bidirectional SOMloq2 (FM 868.95 MHz) radio control system
- Automatic obstacle detection ensures that the barrier opens automatically when it encounters an obstacle so that no vehicle gets wedged in
- The barrier can be manually locked and unlocked in any position (e.g. in the event of a power failure)
- Wide range of connection options for accessories
- Rugged, high-quality components guarantee a long service life
- Pre-programmed Pearl Vibe 4-command handheld transmitter with noticeable feedback of radio commands via vibration



## Boom 400 / 580

- Boom length with 4 m or 5.8 m
- Oval aluminium profile
- Cross-section: 44 × 100 mm
- The oval boom offers maximum stability and minimum resistance to wind load
- Boom lengths can be reduced directly on-site to suit individual requirements.



## Boom 500 LED

- Boom length with 5 m
- Boom with red and green LED lighting for optimum safety
- Oval aluminium profile
- Cross-section: 44 × 100 mm
- The oval boom offers maximum stability and minimum resistance to wind load
- Boom lengths can be reduced directly on-site to suit individual requirements.



An additional "Relay" is required for the traffic-light function.

## Compatibility of barrier body and boom

	Boom 400 (4 m)	Boom 580 (5.8 m)	Boom 500 LED (5 m)
ASB aluminium	✓	✓	✓
ASB steel	✓	✓	–

# THE MATCHING ACCESSORIES FOR THE OPTIMUM BARRIER SYSTEM

## SECURITY

14

### 1 Main switch

The lockable main switch de-energises the barrier at all poles (in acc. with EN 12453).

### 2 Photocell

The photocell detects objects and sends a signal to the control unit when an object is detected. The barrier closing process can be prevented, for example, if there is a vehicle in the access area.

### 3 4 Floating support<sup>1)</sup> and support post<sup>1)</sup>

At a boom length of over 4 metres, the use of a floating support or a support post is recommended for additional stability.

### 5 Induction loops and detectors

For the inductive detection of vehicles. Area for use: Barriers, parking and traffic technology, gates, doors.

### 6 Warning light

The warning light warns users of the barrier of an opening or closing barrier.

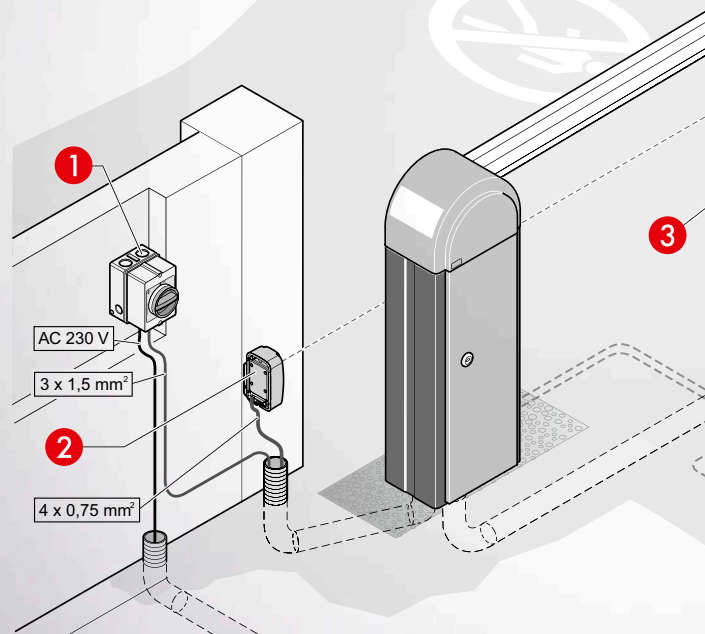



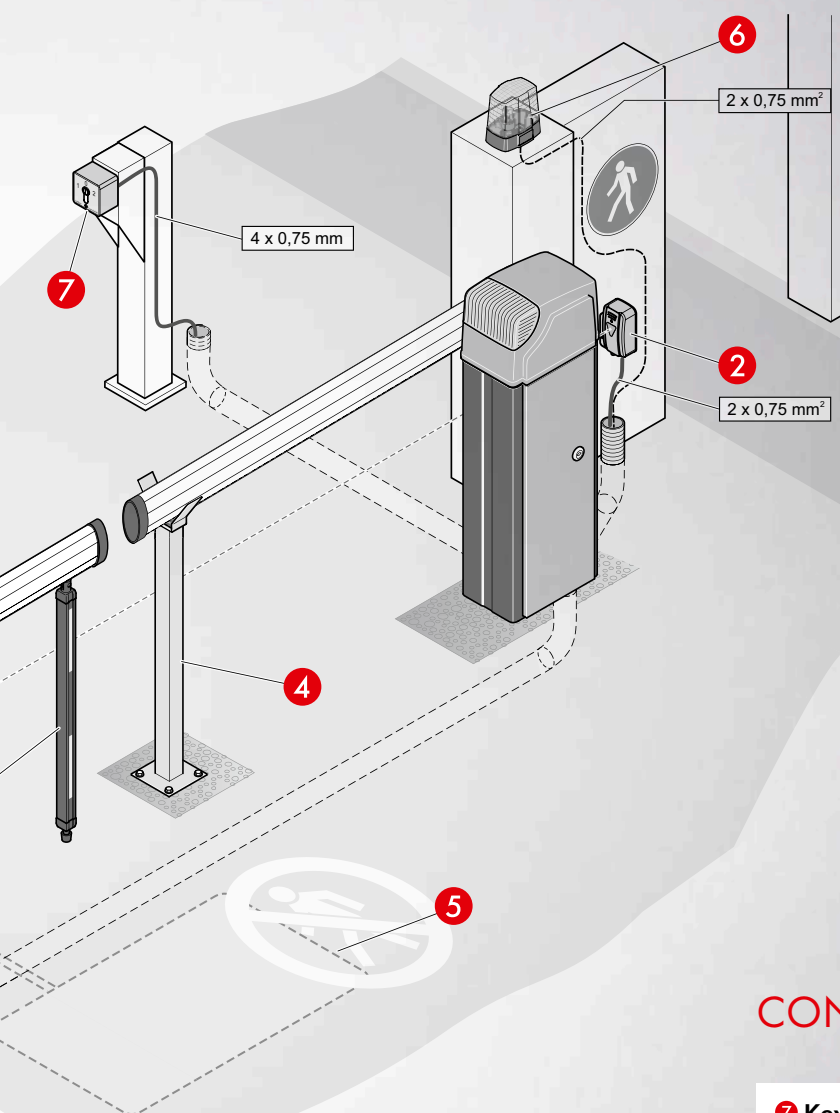

## CONVENIENCE

### 7 Key switch/key switch post

The barrier opens or closes when the key switch is activated. We offer a wide variety of models for wall or recessed installation, either with or without a profile cylinder.

### Radar motion detector

Used as an impulse transmitter for barrier and door systems and enables vehicle or person detection with cross traffic masking.

### Transmitter

Handheld transmitter or Telecody<sup>+</sup>, at SOMMER you'll find the right product tailored to suit your needs, allowing you to operate your barrier system conveniently via radio signal.

# IT'S IN YOUR HANDS

... AND YOU WILL BE AMAZED BY WHAT CAN BE OPERATED BY RADIO TECHNOLOGY AND HOW MUCH CONVENIENCE YOU'LL GAIN

Our radio solutions allow you individual freedom in your own home, in the garden or in the garage.

At SOMMER, security and convenience go hand in hand. Only when you have that peace of mind can you fully reap the benefits of our limitless radio solutions.

## EASY CONVERSION AND RETRO-FITTING WITH RADIO RECEIVERS

16

### SOMplug

#### Radio receiver in power socket housing

This radio receiver allows simple conversion of external operators and easy changing of the radio frequency. Optional feedback via the transmitter when the sent command has been processed by the receiver is also possible.

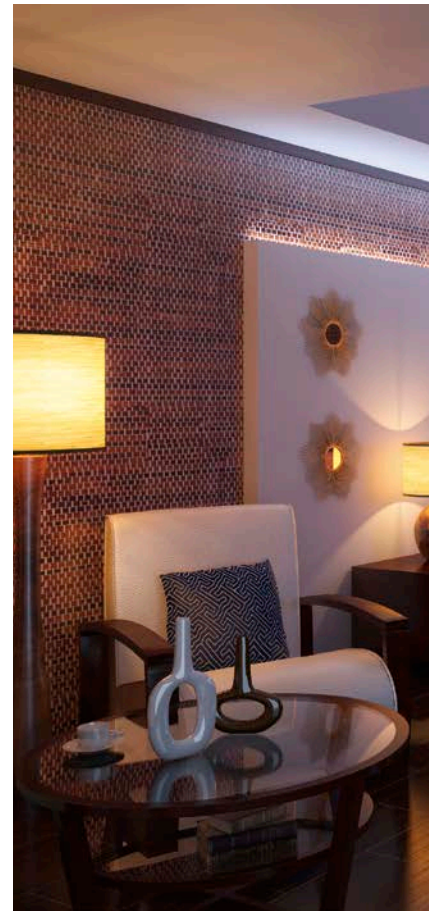

### SOMsocket

#### Radio power socket

The radio power socket can be used to switch the plugged-in application, for example a light, on and off via radio signal. A handheld transmitter can be used for a status query to establish whether the connected consumer is switched on or off.



### Transmitter

Whether a handheld transmitter or a Telecody+, at SOMMER you'll find the right product, for a few to many applications and application areas, private or commercial.



**SOMloq2**  
Pearl Twin  
# S10019-00001

**SOMloq2**  
Pearl Vibe  
# 4019V000

**SOMloq2**  
Telecody+  
# S10212-00001



### Access systems

With the fingerprint systems, you can open garage doors and yard gates with one tiny movement of your finger. The radio code switches allow you to open your garage doors and yard gates with an individually programmable numeric code.



**SOMloq2**  
ENTRAsys+

# S11189-00001

**SOMloq2**  
ENTRAsys+  
flush-mounted  
version

# S11186-00001

**SOMloq2**  
ENTRAcodE+  
surface-mounted  
version

# S11188-00001

17

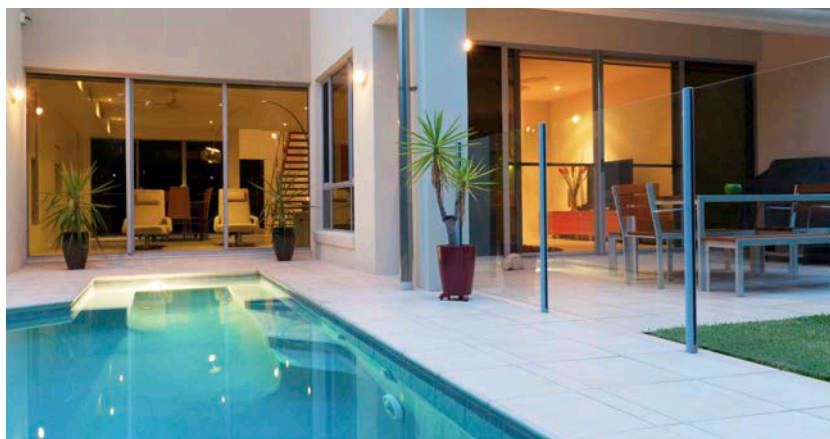

### SOMtouch radio wall button

Home automation applications, such as operators, blinds, roller shutters or awnings, can be operated conveniently using the indoor radio wall buttons. The small key allows a status query.



**SOMloq2**  
# S10447-00001

**SOMloq2**  
# S10447-00002



# SECURITY ASSURED WITH THE PERFECT SOLUTION



18

GARAGE DOOR OPERATORS

UNDERGROUND GARAGE  
OPERATORS

YARD AND OUTDOOR GATE  
OPERATORS

RADIO TECHNOLOGY

SMART HOME

ACCESS SYSTEMS

ROLLER SHUTTER OPERATORS

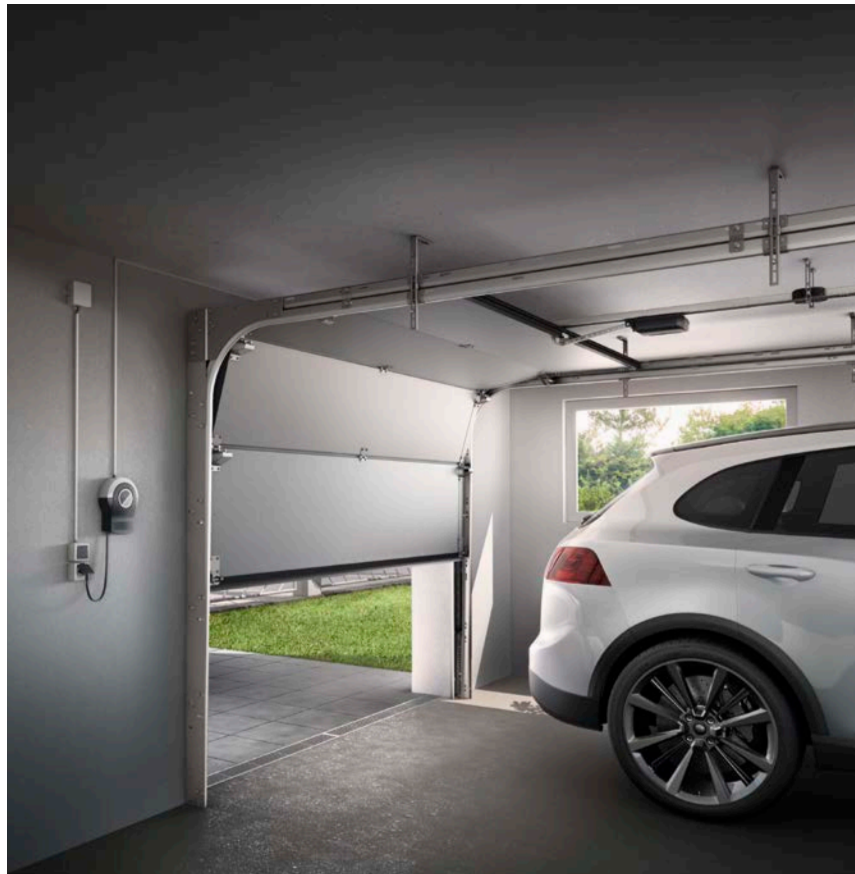

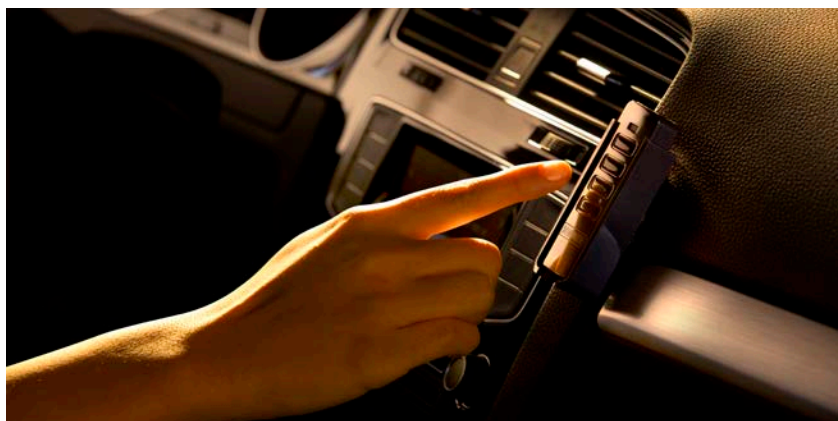

- AWNING OPERATORS
- ROLLER DOOR CONTROL UNITS
- INDUSTRIAL DOOR OPERATORS
- BARRIER SYSTEMS
- ACCESSORIES





DE-EN # S12771.000008: 02/2022. Errors and omissions excepted, subject to technical changes.



**SOMMER ANTRIEBS- UND FUNKTECHNIK GMBH**  
HANS-BÖCKLER-STR. 27 | D-73230 KIRCHHEIM/TECK  
TEL. +49 70 21 80 01-0 | FAX +49 70 21 80 01-100  
INFO@SOMMER.EU | WWW.SOMMER.EU

  SOMMERGMBH